

DATESWEISER

HIGHLINE



table of contents

limited warranty / care and cleaning / terms and conditions.....	3
ordering information.....	4
bases and legs.....	5
conference table pricing.....	6-12
base / wire management column locations.....	13-15
table details.....	16
power / data / AV distribution unit.....	17-18
meeting table pricing.....	20-21
1 high credenza pricing.....	22-23
2 high credenza pricing.....	24-26
3 high credenza pricing.....	27-29
credenza details.....	30-31
accessory boxes.....	32
finishes / materials.....	33

Limited Warranty

DatesWeiser warrants its products to the initial Buyer to be free from defects in materials and workmanship under normal use and service for one year from the date of delivery or placement in storage. This warranty covers goods under normal use and in service under conditions for which the merchandise was designed. This remedy is exclusive and DatesWeiser does not authorize any person to create for it any other obligation or liability. DatesWeiser makes no other warranties, either expressed or implied as to any matter whatsoever, including without limitation the condition of the merchandise its merchantability, or its fitness for any particular use or purpose.

This warranty becomes null and void on any product repaired or altered by any person not so authorized by DatesWeiser Furniture Corporation or on any merchandise which has been damaged or found to be defective due to the Buyer's negligence, lack of care, accident, alteration, misuse, improper storage, improper assembly or installation, improper repair or maintenance, fire or other casualty. The warranty also becomes null and void if the furniture is damaged due to environmental conditions which are detrimental to the furniture such as continued exposure to direct sunlight, building relative humidity outside the range of 30% to 55% and sudden temperature and/or humidity changes.

In addition:

- Stone is a product of nature and DatesWeiser cannot guarantee against color variations or markings
- Customer's Own Material (COM) and Customer's Specified Laminates (CSL) specified by the customer that are not a standard DatesWeiser XO product offering are in no way warranted.

DatesWeiser disclaims any warranty as to any characteristic or quality, including but not limited to:

- the durability or suitability of any exterior surface coatings or treatments or fabric coverings
- the color, grain or texture of wood or stone
- the wearing or fading of any fabric covering
- the matching of color, grains, or texture except as specified in the order acknowledgement and the stain-to-match sample
- irregularities in the registration of printed textile coverage
- the adequacy of any lighting components
- instability of burl and crotch veneers. DatesWeiser takes every quality measure to stabilize burl and crotch veneers, such as using backer, chemical flatteners, adhesives and cross banding

During the warranty period, the exclusive remedy of the Buyer is limited to the following: DatesWeiser will have the option to repair, replace or return the purchase price or some portion thereof, or provide a credit or reimbursement for repair by a third party acceptable to DatesWeiser, of any product which exhibits such material or workmanship defects. DatesWeiser shall not be liable for commercial loss or any consequential or incidental damages that may arise as a result of any defective product. This one limitation may not apply because some states do not allow limitations on the duration of an implied warranty or the exclusion or limitations of incidental or consequential damage.

DatesWeiser must be notified of any claim against this warranty within one year from the date of shipment or placement in storage. To obtain the benefit of this warranty, contact DatesWeiser Furniture Corp., 1700 Broadway, Buffalo, NY 14212, Attention: Claims Department, in writing. Upon notice of claim DatesWeiser will promptly act on the claim and will remedy any material or workmanship defect found to exist. It is the responsibility of the Buyer to arrange for the return of the merchandise to DatesWeiser and to assume all costs relating to any incidental or consequential damages.

Care and Cleaning

Dusting

Regular dusting with a soft cloth will help prevent fine dust particles from becoming embedded in the finished surface. We recommend using a soft flannel cloth slightly dampened with water, followed by a dry cloth. Always wipe in the direction of the grain. Caution: *Never use a chemically treated cleaning cloth.*

Cleaning

For removing residues, smudges, etc. we recommend using a very mild (non-ammonia) soap and water solution. Apply with a soft flannel cloth, followed by a dry cloth. Always wipe in the direction of the grain.

Fabric

As it's important to keep your fabric items clean, we recommend vacuuming upholstery as often as necessary. If more extensive cleaning is necessary, we advise consulting with a local cleaning specialist. If you are still concerned or uncertain, feel free to call DatesWeiser for assistance.

Stone and Metal

Most stone and metal surfaces can be cleaned following the same procedures as with our wood products. Granite and marble are both very porous and stain very easily. Lemon juice and other acids can actually etch the surface of the stone. Many stains are extremely difficult or impossible to remove, so please be careful. If a problem arises, please contact DatesWeiser or a specialist in your area.

Glass

You may use a standard brand of glass cleaner that does not contain ammonia or vinegar. Always use a soft, clean, grit free cloth when cleaning to reduce the chances of scratching the surface. We recommend a micro-fiber cloth and not paper towels. Care and cleaning of clear or acid-etched glass are the same.

As far as substances are concerned, on non-tempered glass avoid extremely hot materials and on all glass avoid caustic substances.

Harmful Materials

Certain vinyl and rubber products can chemically react with the finish, left in contact for extended periods of time. Coasters, place mats, notebook covers, and rubber or plastic feet (found on most accessories) can also damage wood surfaces. We recommend using felt pads on all objects that come in contact with furniture. To avoid indentations caused by writing instruments, always use a non-vinyl blotter or writing pad.

Environment

All furniture should be used in a stable, controlled atmosphere; avoid sudden temperature and humidity changes. Avoid direct sunlight. The ideal climate is 65 to 75 degrees Fahrenheit and 30 to 55 % relative humidity.

Terms and Conditions

Selling Policy: Sales by DatesWeiser Furniture Corporation are made only on the terms and conditions set forth below. These terms and conditions may be modified or supplemented only by a written document signed by an authorized representative of Seller. These terms and conditions supercede any prior and/or contemporaneous agreements or correspondence between Purchaser and Seller.

Quotations: All written quotations expire 30 days from the date of issuance and can be withdrawn by written notice anytime during that period.

Prices: Prices are F.O.B. from the DatesWeiser factory in Buffalo, NY. Shipping, packaging, inside delivery, uncrating, installation, storage and sales tax (if applicable) shall be in addition to the price and shall be itemized and charged separately.

Net prices are subject to change without notice.

Net prices shall be those prices in effect on the date of receipt of a complete purchase order unless shipment is requested more than one hundred twenty days after order entry in which case prices in effect on the date of shipment apply.

Minimum Order: The minimum order that DatesWeiser will accept is \$100.

Terms: Unless otherwise specified, all amounts are quoted in U.S. funds. All orders require a fifty percent (50%) deposit due at time of order. Account balances are due in full within 30 days after delivery. After 30 days, a 1 1/2% per month finance charge will be assessed on all past due accounts, commencing as of the date of delivery. Buyer is also responsible for any collection costs, including attorney fees, incurred by DatesWeiser in collecting a delinquent account. All orders for DatesWeiser furniture are subject to credit approval prior to shipment. A purchase is not binding on Seller until Purchaser has received Seller's Order Confirmation or Acknowledgement.

Ship Date Confirmation: The ship date will be confirmed via a separate DatesWeiser acknowledgement that will be issued upon receipt of a signed purchase order.

Ordering Information

Ordering Acknowledgements: All orders and subsequent change orders must be in writing. DatesWeiser will issue a written acknowledgement. This price list details what information must be noted on the purchase order. Any omission may result in the delay of processing your order.

Claims: DatesWeiser Corporation is not responsible for damage to merchandise which occurs in transit or storage. It is the customer's responsibility to examine furniture upon receipt and note any damage in transit on the carrier's delivery receipt.

Cancellations: Acknowledged orders, including order changes, may not be canceled without written consent by DatesWeiser. If a cancellation is approved, the order will be subject to cancellation charges consisting of a \$500 administrative fee plus any manufacturing expenses incurred by DatesWeiser.

For claims covering damage due to shipping, merchandise should be examined immediately by Buyer when received and any obvious damage should be noted on carrier's delivery receipt. The merchandise should not be refused, but written exception should be made on the bill of lading and the Buyer should request immediate inspection by the carrier. DatesWeiser must also be notified of all shipping damages. Damage that becomes apparent after the merchandise is unpacked should be reported to the carrier and DatesWeiser immediately upon discovery.

Damage that is incurred at a furniture dealer's warehouse is the responsibility of the furniture dealer.

Claims for defects, errors or shortages must be made by Buyer against DatesWeiser in writing within five (5) working days after delivery. Failure to make such claim against DatesWeiser within five (5) working days shall constitute unconditional acceptance of the merchandise and a waiver of any defects, errors or shortages discoverable upon inspection. DatesWeiser shall not be liable for consequential damages.

Sales Tax: DatesWeiser Furniture Corporation is authorized to collect sales tax in New York State and Illinois only. For all orders with point of delivery outside of New York State or Illinois, the customer will be required to remit the sales tax directly to the appropriate government agency.

All sales, use, excise and other taxes applicable to the sale of the products shall be paid by the Purchaser. If Purchaser claims an exemption from any tax, Purchaser shall submit to Seller the appropriate exemption certificates prior to shipment.

Ordering Instructions: DatesWeiser quotes pricing based on specifications provided by the Buyer. DatesWeiser quotations reflect DatesWeiser's interpretation of the specifications. A purchase order must be received by DatesWeiser for the Buyer's order to be acknowledged and work to begin. Items on the Buyer's signed purchase order will correlate to detailed product description on the DatesWeiser quotation.

All orders are subject to acceptance by DatesWeiser Furniture Corporation in Buffalo, NY. Receipt by Buyer of DatesWeiser's order acknowledgement indicates acceptance of Buyer's order subject to the terms set forth herein and the acknowledgement and is final and binding. The order acknowledgement will be considered the final expression of the agreement between the Buyer and DatesWeiser and shall be the exclusive expression of the terms thereof. The order acknowledgement supercedes all prior writings and may not be modified or rescinded except by a revised DatesWeiser acknowledgement. No orders are binding on DatesWeiser until execution of the order acknowledgement.

Customer's Own Material: A Purchaser who requests a fabric or other surface material not standard to Seller's line of Products ("COM") must submit sample of the requested material to Seller prior to entry of a purchase order. Seller shall determine if the material is suitable to its manufacturing processes and meets any requirements of Underwriter Laboratories. If the "COM" is acceptable, Seller will then establish a price for using the "COM" or the Product in question.

Order Changes: DatesWeiser is not required to accept any requested change order after order acknowledgement; however, all reasonable requests for changes will be honored. All requests for order changes must be in writing, signed by the Buyer or Buyer's agent, and confirmed in writing by DatesWeiser in order to be effective. Any order change accepted after order acknowledgement is subject to our ability to conform and will be subject to a charge for materials, labor and other costs involved in the change depending on the status of the order at the time of the change request.

Delay of Shipment and Storage Charges: If the Buyer cannot accept delivery of the merchandise per the ship date specified in the DatesWeiser acknowledgement, DatesWeiser may transfer the merchandise to storage, either at DatesWeiser's facility or at another facility. If the furniture is stored at DatesWeiser's facility, a storage fee of 2 % of invoice will be assessed for every thirty (30) days. If the furniture is stored in another facility, all out-of-pocket costs of storage, including transportation and warehousing fees, will be at the Buyer's expense. DatesWeiser considers the ship date specified in the DatesWeiser acknowledgement as the invoice date for billing purposes and the customer will be invoiced for all product charges on the date that the furniture is transferred to storage. Storage fees will accrue monthly in full month increments (they are not prorated for partial months) and will be added to the first invoice, which will also include non-product charges such as shipping, installation, etc.

Shipping: Products are carefully inspected and packaged before leaving the factory to ensure that the product will reach its destination in excellent condition. DatesWeiser will ship in accordance with Buyer instructions whenever possible. However, if Buyer does not specifically indicate instructions as to shipping method and route, then DatesWeiser will exercise its best judgment in determining the most suitable shipping method and carrier. DatesWeiser is not liable for any delay or failure to deliver or performance due to strikes, lockouts, or other labor difficulties, failure or delay of sources of supply, transportation difficulties, accidents, fires, Acts of God, or any other cause beyond its control.

Returns: Merchandise may not be returned to DatesWeiser unless Buyer receives prior approval and shipping instructions in writing from DatesWeiser. Unauthorized returns and returns shipped inconsistently with instructions will be automatically refused by the receiving department at DatesWeiser.

Title: Title to the Product shall remain with the Seller until the Product is fully paid for. Purchaser agrees to perform all acts which may be necessary to perfect and assure retention of title by Seller.

Furniture Hardware: DatesWeiser adjusts all furniture hardware-hinges, drawer slides, drawer pulls, etc.-at the installation and as a punch list item, if required. Any subsequent adjustment is the Buyer's responsibility.

Design: All products shown in the DatesWeiser catalogs are, and remain, the property of DatesWeiser and DatesWeiser reserves the exclusive right to manufacture the models shown. All dimensions shown are to be considered approximate. DatesWeiser reserves the right to make changes in price, dimensions, design and/or construction without prior notice.

Wood Finishes: All DatesWeiser finishes are semi-filled, medium sheen. The natural characteristics of wood veneer and wood solids may contribute to a variation of finish grain, tone, and color. Natural finish options are an absolutely clear finish and the color will reflect the variations of the veneers used on different components within an office.

Custom Finishes: For custom wood or paint finishes add \$723 net per finish. This is a one time matching charge. Custom finishes may extend delivery time up to 4 weeks. Counter samples of custom finishes will be provided. Extended delivery time may be necessary pending customer approval of sample.

bases / legs

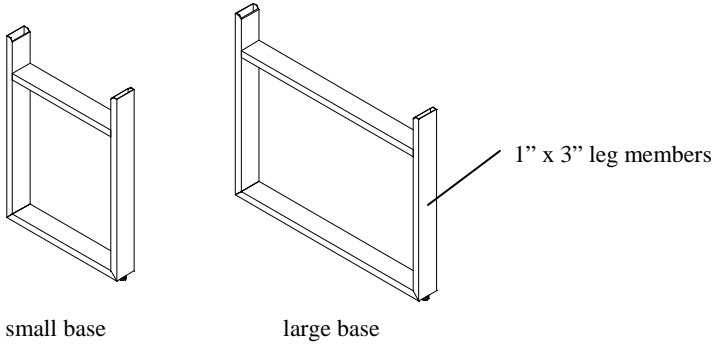

conference table bases

- 1) metal base finishes, see pg. 33
- 2) small base used on tables 42", 48 & 54" wide
- 3) large base used on tables 60" & 72" wide

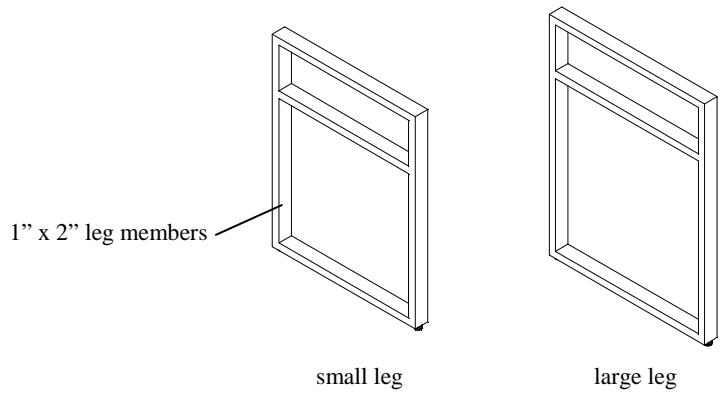

credenza legs

- 1) metal base finishes, see pg. 33
- 2) small leg used on 1 & 2 high credenzas
- 3) large leg used on 3 high credenzas

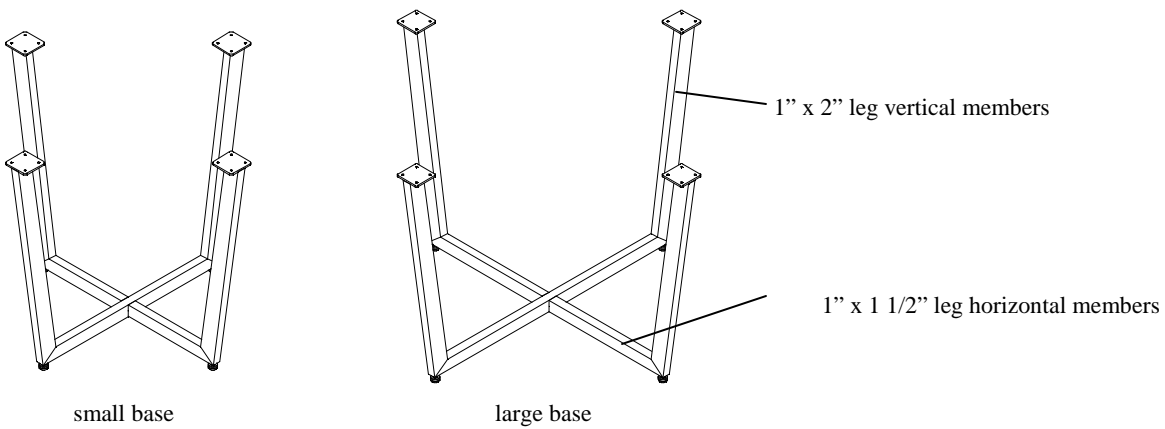

meeting table bases

- 1) metal base finishes, see pg. 33
- 2) small base used on 48" meeting tables
- 3) large base used on 60" meeting tables

conference table pricing

84" x 42" rectangular conference table

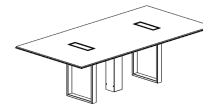
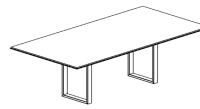

veneer	top thickness	metal finish	no power data	power data boxes	add crate (net \$)
standard knife/square edge	3/4"	chrome / satin nickel	\$7,025	\$8,828	n/a
premium knife/square edge	3/4"	chrome / satin nickel	\$7,650	\$9,454	n/a
solid surface	top thickness	metal finish	no power data	power data boxes	add crate (net \$)
square edge	1/2"	chrome / satin nickel	\$7,133	\$9,015	\$240
knife edge	3/4"	chrome / satin nickel	\$9,739	\$11,674	\$240
back painted glass	top thickness	metal finish	no power data	power data boxes	add crate (net \$)
square edge	1/2"	chrome / satin nickel	\$7,931	\$9,944	\$240
square edge acid etched	1/2"	chrome / satin nickel	\$9,854	\$11,993	\$240
stone	top thickness	metal finish	no power data	power data boxes	add crate (net \$)
standard square edge	3/4"	chrome / satin nickel	\$12,947	\$16,190	\$240
standard knife edge	3/4"	chrome / satin nickel	\$13,204	\$16,447	\$240
premium square edge	3/4"	chrome / satin nickel	\$19,360	\$22,603	\$240
premium knife edge	3/4"	chrome / satin nickel	\$19,744	\$22,987	\$240

*add 10% for oil rubbed bronze metal option

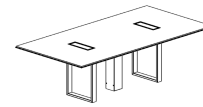
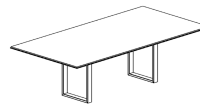

96" x 48" rectangular conference table

veneer	top thickness	metal finish	no power data	power data boxes	add crate (net \$)
standard knife/square edge	3/4"	chrome / satin nickel	\$7,683	\$9,491	n/a
premium knife/square edge	3/4"	chrome / satin nickel	\$8,492	\$10,301	n/a
solid surface	top thickness	metal finish	no power data	power data boxes	add crate (net \$)
square edge	1/2"	chrome / satin nickel	\$7,391	\$9,277	\$270
knife edge	3/4"	chrome / satin nickel	\$10,071	\$12,010	\$270
back painted glass	top thickness	metal finish	no power data	power data boxes	add crate (net \$)
square edge	1/2"	chrome / satin nickel	\$9,118	\$11,136	\$270
square edge acid etched	1/2"	chrome / satin nickel	\$11,631	\$13,774	\$270
stone	top thickness	metal finish	no power data	power data boxes	add crate (net \$)
standard square edge	3/4"	chrome / satin nickel	\$17,363	\$20,770	\$270
standard knife edge	3/4"	chrome / satin nickel	\$17,735	\$21,143	\$270
premium square edge	3/4"	chrome / satin nickel	\$24,002	\$27,250	\$270
premium knife edge	3/4"	chrome / satin nickel	\$24,504	\$27,752	\$270

*add 10% for oil rubbed bronze metal option

- notes
- 1) materials / finishes, see pg. 33
 - 2) wire management towers are available in (3) powder coat finishes, see pg. 33
 - 3) table details / information, see pg. 16
 - 4) edge profiles / details, see pg. 16
 - 5) hatch door details, see pg. 16
 - 6) power | data | AV distribution unit, see pg. 17-18
 - 7) all **electrical, data** and **AV components** are **supplied by others**, see examples on pg. 18
 - 8) table height +/-29 1/4"
 - 9) base information, see pg. 5
 - 10) top sections are for reference when using stone, top sections are subject to change based on availability of stone material

conference table pricing, *continued*

108" x 48" rectangular conference table

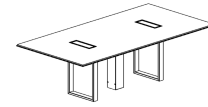
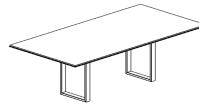

veneer	top thickness	metal finish	no power data	power data boxes	add crate (net \$)
standard knife/square edge	3/4"	chrome / satin nickel	\$8,481	\$10,289	n/a
premium knife/square edge	3/4"	chrome / satin nickel	\$9,390	\$11,198	n/a
solid surface	top thickness	metal finish	no power data	power data boxes	add crate (net \$)
square edge	1/2"	chrome / satin nickel	\$7,942	\$9,829	\$305
knife edge	3/4"	chrome / satin nickel	\$11,308	\$13,247	\$305
back painted glass	top thickness	metal finish	no power data	power data boxes	add crate (net \$)
square edge	1/2"	chrome / satin nickel	\$10,167	\$12,184	\$305
square edge acid etched	1/2"	chrome / satin nickel	\$12,993	\$15,136	\$305
stone	top thickness	metal finish	no power data	power data boxes	add crate (net \$)
standard square edge	3/4"	chrome / satin nickel	\$19,412	\$22,819	\$305
standard knife edge	3/4"	chrome / satin nickel	\$19,830	\$23,238	\$305
premium square edge	3/4"	chrome / satin nickel	\$26,893	\$30,140	\$305
premium knife edge	3/4"	chrome / satin nickel	\$27,458	\$30,706	\$305

*add 10% for oil rubbed bronze metal option

120" x 48" rectangular conference table

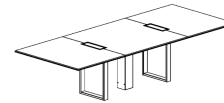
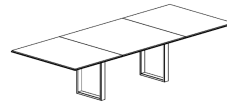

veneer	top thickness	metal finish	no power data	power data boxes	add crate (net \$)
standard knife/square edge	3/4"	chrome / satin nickel	\$9,677	\$11,486	n/a
premium knife/square edge	3/4"	chrome / satin nickel	\$10,686	\$12,494	n/a
solid surface	top thickness	metal finish	no power data	power data boxes	add crate (net \$)
square edge	1/2"	chrome / satin nickel	\$9,599	\$11,570	\$340
knife edge	3/4"	chrome / satin nickel	\$13,787	\$15,883	\$340
back painted glass	top thickness	metal finish	no power data	power data boxes	add crate (net \$)
square edge	1/2"	chrome / satin nickel	\$12,242	\$14,399	\$340
square edge acid etched	1/2"	chrome / satin nickel	\$15,732	\$18,098	\$340
stone	top thickness	metal finish	no power data	power data boxes	add crate (net \$)
standard square edge	3/4"	chrome / satin nickel	\$24,254	\$27,122	\$340
standard knife edge	3/4"	chrome / satin nickel	\$25,251	\$28,119	\$340
premium square edge	3/4"	chrome / satin nickel	\$30,215	\$32,913	\$340
premium knife edge	3/4"	chrome / satin nickel	\$31,052	\$33,750	\$340

*add 10% for oil rubbed bronze metal option

notes

- 1) materials / finishes, see pg. 33
- 2) wire management towers are available in (3) powder coat finishes, see pg. 33
- 3) table details / information, see pg. 16
- 4) edge profiles / details, see pg. 16
- 5) hatch door details, see pg. 16
- 6) power | data | AV distribution unit, see pg. 17-18
- 7) all **electrical, data and AV components** are **supplied by others**, see examples on pg. 18
- 8) table height +/-29 1/4"
- 9) base information, see pg. 5
- 10) top sections are for reference when using stone, top sections are subject to change based on availability of stone material

conference table pricing, *continued*

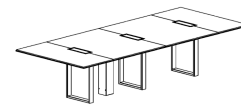
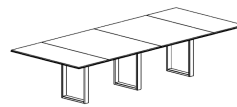

132" x 54" rectangular conference table

veneer	top thickness	metal finish	no power data	power data boxes	add crate (net \$)
standard knife/square edge	3/4"	chrome / satin nickel	\$11,950	\$14,607	n/a
premium knife/square edge	3/4"	chrome / satin nickel	\$13,190	\$15,847	n/a
solid surface	top thickness	metal finish	no power data	power data boxes	add crate (net \$)
square edge	1/2"	chrome / satin nickel	\$11,350	\$14,247	\$375
knife edge	3/4"	chrome / satin nickel	\$16,333	\$19,409	\$375
back painted glass	top thickness	metal finish	no power data	power data boxes	add crate (net \$)
square edge	1/2"	chrome / satin nickel	\$13,567	\$16,616	\$375
square edge acid etched	1/2"	chrome / satin nickel	\$17,453	\$20,738	\$375
stone	top thickness	metal finish	no power data	power data boxes	add crate (net \$)
standard square edge	3/4"	chrome / satin nickel	\$25,180	\$29,171	\$375
standard knife edge	3/4"	chrome / satin nickel	\$26,219	\$30,210	\$375
premium square edge	3/4"	chrome / satin nickel	\$37,361	\$41,352	\$375
premium knife edge	3/4"	chrome / satin nickel	\$38,397	\$42,388	\$375

*add 10% for oil rubbed bronze metal option

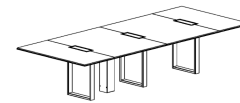
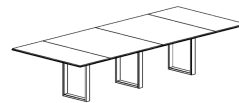

144" x 54" rectangular conference table

veneer	top thickness	metal finish	no power data	power data boxes	add crate (net \$)
standard knife/square edge	3/4"	chrome / satin nickel	\$12,927	\$15,584	n/a
premium knife/square edge	3/4"	chrome / satin nickel	\$14,279	\$16,936	n/a
solid surface	top thickness	metal finish	no power data	power data boxes	add crate (net \$)
square edge	1/2"	chrome / satin nickel	\$12,118	\$15,005	\$405
knife edge	3/4"	chrome / satin nickel	\$17,123	\$20,198	\$405
back painted glass	top thickness	metal finish	no power data	power data boxes	add crate (net \$)
square edge	1/2"	chrome / satin nickel	\$14,861	\$17,911	\$405
square edge acid etched	1/2"	chrome / satin nickel	\$19,101	\$22,386	\$405
stone	top thickness	metal finish	no power data	power data boxes	add crate (net \$)
standard square edge	3/4"	chrome / satin nickel	\$27,513	\$31,505	\$405
standard knife edge	3/4"	chrome / satin nickel	\$28,644	\$32,636	\$405
premium square edge	3/4"	chrome / satin nickel	\$40,799	\$44,790	\$405
premium knife edge	3/4"	chrome / satin nickel	\$41,929	\$45,921	\$405

*add 10% for oil rubbed bronze metal option

- notes
- 1) materials / finishes, see pg. 33
 - 2) wire management towers are available in (3) powder coat finishes, see pg. 33
 - 3) table details / information, see pg. 16
 - 4) edge profiles / details, see pg. 16
 - 5) hatch door details, see pg. 16
 - 6) power | data | AV distribution unit, see pg. 17-18
 - 7) all **electrical, data** and **AV components** are **supplied by others**, see examples on pg. 18
 - 8) table height +/-29 1/4"
 - 9) base information, see pg. 5
 - 10) top sections are for reference when using stone, top sections are subject to change based on availability of stone material

conference table pricing, *continued*

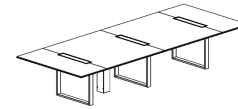
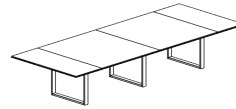

156" x 60" rectangular conference table

veneer	top thickness	metal finish	no power data	power data boxes	add crate (net \$)
standard knife/square edge	3/4"	chrome / satin nickel	\$15,749	\$19,084	n/a
premium knife/square edge	3/4"	chrome / satin nickel	\$17,549	\$20,883	n/a
solid surface	top thickness	metal finish	no power data	power data boxes	add crate (net \$)
square edge	1/2"	chrome / satin nickel	\$15,015	\$18,617	\$475
knife edge	3/4"	chrome / satin nickel	\$21,785	\$25,585	\$475
back painted glass	top thickness	metal finish	no power data	power data boxes	add crate (net \$)
square edge	1/2"	chrome / satin nickel	\$18,685	\$22,543	\$475
square edge acid etched	1/2"	chrome / satin nickel	\$24,355	\$28,528	\$475
stone	top thickness	metal finish	no power data	power data boxes	add crate (net \$)
standard square edge	3/4"	chrome / satin nickel	\$35,603	\$40,537	\$475
standard knife edge	3/4"	chrome / satin nickel	\$37,115	\$42,049	\$475
premium square edge	3/4"	chrome / satin nickel	\$53,371	\$58,305	\$475
premium knife edge	3/4"	chrome / satin nickel	\$54,883	\$59,818	\$475

**add 10% for oil rubbed bronze metal option*

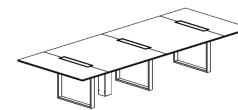
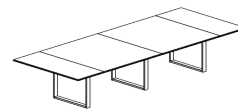

168" x 60" rectangular conference table

veneer	top thickness	metal finish	no power data	power data boxes	add crate (net \$)
standard knife/square edge	3/4"	chrome / satin nickel	\$16,441	\$19,775	n/a
premium knife/square edge	3/4"	chrome / satin nickel	\$18,376	\$21,711	n/a
solid surface	top thickness	metal finish	no power data	power data boxes	add crate (net \$)
square edge	1/2"	chrome / satin nickel	\$15,420	\$19,010	\$525
knife edge	3/4"	chrome / satin nickel	\$22,213	\$26,013	\$525
back painted glass	top thickness	metal finish	no power data	power data boxes	add crate (net \$)
square edge	1/2"	chrome / satin nickel	\$19,747	\$23,605	\$525
square edge acid etched	1/2"	chrome / satin nickel	\$25,854	\$30,026	\$525
stone	top thickness	metal finish	no power data	power data boxes	add crate (net \$)
standard square edge	3/4"	chrome / satin nickel	\$40,655	\$45,704	\$525
standard knife edge	3/4"	chrome / satin nickel	\$42,400	\$47,448	\$525
premium square edge	3/4"	chrome / satin nickel	\$57,080	\$62,014	\$525
premium knife edge	3/4"	chrome / satin nickel	\$58,709	\$63,643	\$525

**add 10% for oil rubbed bronze metal option*

notes

- 1) materials / finishes, see pg. 33
- 2) wire management towers are available in (3) powder coat finishes, see pg. 33
- 3) table details / information, see pg. 16
- 4) edge profiles / details, see pg. 16
- 5) hatch door details, see pg. 16
- 6) power | data | AV distribution unit, see pg. 17-18
- 7) all **electrical, data and AV components** are **supplied by others**, see examples on pg. 18
- 8) table height +/-29 1/4"
- 9) base information, see pg. 5
- 10) top sections are for reference when using stone, top sections are subject to change based on availability of stone material

conference table pricing, *continued*

180" x 60" rectangular conference table

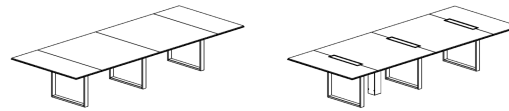

veneer	top thickness	metal finish	no power data	power data boxes	add crate (net \$)
standard knife/square edge	3/4"	chrome / satin nickel	\$16,995	\$20,330	n/a
premium knife/square edge	3/4"	chrome / satin nickel	\$19,068	\$22,402	n/a
solid surface	top thickness	metal finish	no power data	power data boxes	add crate (net \$)
square edge	1/2"	chrome / satin nickel	\$16,908	\$20,511	\$575
knife edge	3/4"	chrome / satin nickel	\$24,597	\$28,397	\$575
back painted glass	top thickness	metal finish	no power data	power data boxes	add crate (net \$)
square edge	1/2"	chrome / satin nickel	\$20,695	\$24,553	\$575
square edge acid etched	1/2"	chrome / satin nickel	\$27,238	\$31,410	\$575
stone	top thickness	metal finish	no power data	power data boxes	add crate (net \$)
standard square edge	3/4"	chrome / satin nickel	\$40,172	\$45,106	\$575
standard knife edge	3/4"	chrome / satin nickel	\$41,917	\$46,851	\$575
premium square edge	3/4"	chrome / satin nickel	\$60,674	\$65,608	\$575
premium knife edge	3/4"	chrome / satin nickel	\$62,419	\$67,353	\$575

*add 10% for oil rubbed bronze metal option

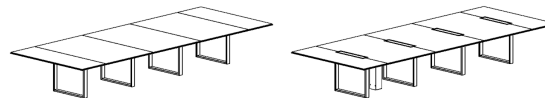

192" x 72" rectangular conference table

veneer	top thickness	metal finish	no power data	power data boxes	add crate (net \$)
standard knife/square edge	3/4"	chrome / satin nickel	\$19,966	\$24,382	n/a
premium knife/square edge	3/4"	chrome / satin nickel	\$22,603	\$27,018	n/a
solid surface	top thickness	metal finish	no power data	power data boxes	add crate (net \$)
square edge	1/2"	chrome / satin nickel	\$19,792	\$24,563	\$600
knife edge	3/4"	chrome / satin nickel	\$30,250	\$35,276	\$600
back painted glass	top thickness	metal finish	no power data	power data boxes	add crate (net \$)
square edge	1/2"	chrome / satin nickel	\$24,800	\$29,913	\$600
square edge acid etched	1/2"	chrome / satin nickel	\$33,175	\$38,708	\$600
stone	top thickness	metal finish	no power data	power data boxes	add crate (net \$)
standard square edge	3/4"	chrome / satin nickel	\$52,538	\$59,082	\$600
standard knife edge	3/4"	chrome / satin nickel	\$54,213	\$60,757	\$600
premium square edge	3/4"	chrome / satin nickel	\$96,090	\$102,634	\$600
premium knife edge	3/4"	chrome / satin nickel	\$98,881	\$105,426	\$600

*add 10% for oil rubbed bronze metal option

- notes
- 1) materials / finishes, see pg. 33
 - 2) wire management towers are available in (3) powder coat finishes, see pg. 33
 - 3) table details / information, see pg. 16
 - 4) edge profiles / details, see pg. 16
 - 5) hatch door details, see pg. 16
 - 6) power | data | AV distribution unit, see pg. 17-18
 - 7) all **electrical, data** and **AV components** are **supplied by others**, see examples on pg. 18
 - 8) table height +/-29 1/4"
 - 9) base information, see pg. 5
 - 10) top sections are for reference when using stone, top sections are subject to change based on availability of stone material

conference table pricing, *continued*

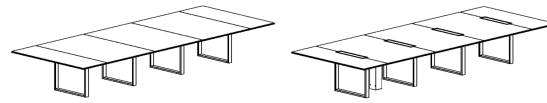

204" x 72" rectangular conference table

veneer	top thickness	metal finish	no power data	power data boxes	add crate (net \$)
standard knife/square edge	3/4"	chrome / satin nickel	\$21,300	\$25,716	n/a
premium knife/square edge	3/4"	chrome / satin nickel	\$24,100	\$28,515	n/a
solid surface	top thickness	metal finish	no power data	power data boxes	add crate (net \$)
square edge	1/2"	chrome / satin nickel	\$20,672	\$25,443	\$625
knife edge	3/4"	chrome / satin nickel	\$31,165	\$36,191	\$625
back painted glass	top thickness	metal finish	no power data	power data boxes	add crate (net \$)
square edge	1/2"	chrome / satin nickel	\$26,494	\$31,608	\$625
square edge acid etched	1/2"	chrome / satin nickel	\$35,393	\$40,925	\$625
stone	top thickness	metal finish	no power data	power data boxes	add crate (net \$)
standard square edge	3/4"	chrome / satin nickel	\$55,942	\$62,486	\$625
standard knife edge	3/4"	chrome / satin nickel	\$57,722	\$64,266	\$625
premium square edge	3/4"	chrome / satin nickel	\$102,216	\$108,760	\$625
premium knife edge	3/4"	chrome / satin nickel	\$105,182	\$111,726	\$625

*add 10% for oil rubbed bronze metal option

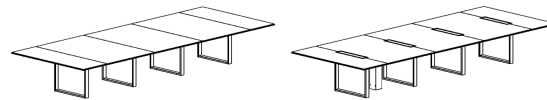

216" x 72" rectangular conference table

veneer	top thickness	metal finish	no power data	power data boxes	add crate (net \$)
standard knife/square edge	3/4"	chrome / satin nickel	\$22,390	\$26,805	n/a
premium knife/square edge	3/4"	chrome / satin nickel	\$25,353	\$29,768	n/a
solid surface	top thickness	metal finish	no power data	power data boxes	add crate (net \$)
square edge	1/2"	chrome / satin nickel	\$22,444	\$27,215	\$675
knife edge	3/4"	chrome / satin nickel	\$33,786	\$38,812	\$675
back painted glass	top thickness	metal finish	no power data	power data boxes	add crate (net \$)
square edge	1/2"	chrome / satin nickel	\$27,918	\$33,031	\$675
square edge acid etched	1/2"	chrome / satin nickel	\$37,340	\$42,872	\$675
stone	top thickness	metal finish	no power data	power data boxes	add crate (net \$)
standard square edge	3/4"	chrome / satin nickel	\$59,075	\$65,619	\$675
standard knife edge	3/4"	chrome / satin nickel	\$60,960	\$67,504	\$675
premium square edge	3/4"	chrome / satin nickel	\$108,071	\$114,615	\$675
premium knife edge	3/4"	chrome / satin nickel	\$111,212	\$117,756	\$675

*add 10% for oil rubbed bronze metal option

notes

- 1) materials / finishes, see pg. 33
- 2) wire management towers are available in (3) powder coat finishes, see pg. 33
- 3) table details / information, see pg. 16
- 4) edge profiles / details, see pg. 16
- 5) hatch door details, see pg. 16
- 6) power | data | AV distribution unit, see pg. 17-18
- 7) all **electrical, data** and **AV components** are **supplied by others**, see examples on pg. 18
- 8) table height +/-29 1/4"
- 9) base information, see pg. 5
- 10) top sections are for reference when using stone, top sections are subject to change based on availability of stone material

conference table pricing, *continued*

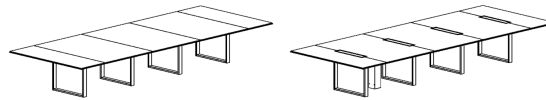

228" x 72" rectangular conference table

veneer	top thickness	metal finish	no power data	power data boxes	add crate (net \$)
standard knife/square edge	3/4"	chrome / satin nickel	\$22,926	\$27,342	n/a
premium knife/square edge	3/4"	chrome / satin nickel	\$26,052	\$30,468	n/a
solid surface	top thickness	metal finish	no power data	power data boxes	add crate (net \$)
square edge	1/2"	chrome / satin nickel	\$21,744	\$27,426	\$710
knife edge	3/4"	chrome / satin nickel	\$34,082	\$39,108	\$710
back painted glass	top thickness	metal finish	no power data	power data boxes	add crate (net \$)
square edge	1/2"	chrome / satin nickel	\$28,969	\$34,141	\$710
square edge acid etched	1/2"	chrome / satin nickel	\$38,915	\$44,540	\$710
stone	top thickness	metal finish	no power data	power data boxes	add crate (net \$)
standard square edge	3/4"	chrome / satin nickel	\$61,837	\$68,381	\$710
standard knife edge	3/4"	chrome / satin nickel	\$63,826	\$70,370	\$710
premium square edge	3/4"	chrome / satin nickel	\$113,555	\$120,099	\$710
premium knife edge	3/4"	chrome / satin nickel	\$116,870	\$123,414	\$710

*add 10% for oil rubbed bronze metal option

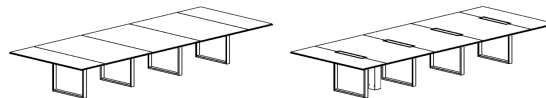

240" x 72" rectangular conference table

veneer	top thickness	metal finish	no power data	power data boxes	add crate (net \$)
standard knife/square edge	3/4"	chrome / satin nickel	\$23,798	\$28,213	n/a
premium knife/square edge	3/4"	chrome / satin nickel	\$27,087	\$31,502	n/a
solid surface	top thickness	metal finish	no power data	power data boxes	add crate (net \$)
square edge	1/2"	chrome / satin nickel	\$22,978	\$27,748	\$750
knife edge	3/4"	chrome / satin nickel	\$34,511	\$39,537	\$750
back painted glass	top thickness	metal finish	no power data	power data boxes	add crate (net \$)
square edge	1/2"	chrome / satin nickel	\$30,108	\$35,222	\$750
square edge acid etched	1/2"	chrome / satin nickel	\$40,578	\$46,110	\$750
stone	top thickness	metal finish	no power data	power data boxes	add crate (net \$)
standard square edge	3/4"	chrome / satin nickel	\$64,733	\$71,230	\$750
standard knife edge	3/4"	chrome / satin nickel	\$66,780	\$73,324	\$750
premium square edge	3/4"	chrome / satin nickel	\$119,126	\$125,670	\$750
premium knife edge	3/4"	chrome / satin nickel	\$122,615	\$129,160	\$750

*add 10% for oil rubbed bronze metal option

- notes
- 1) materials / finishes, see pg. 33
 - 2) wire management towers are available in (3) powder coat finishes, see pg. 33
 - 3) table details / information, see pg. 16
 - 4) edge profiles / details, see pg. 16
 - 5) hatch door details, see pg. 16
 - 6) power | data | AV distribution unit, see pg. 17-18
 - 7) all **electrical, data** and **AV components** are **supplied by others**, see examples on pg. 18
 - 8) table height +/-29 1/4"
 - 9) base information, see pg. 5
 - 10) top sections are for reference when using stone, top sections are subject to change based on availability of stone material

base / wire management column locations - tables with 2 bases

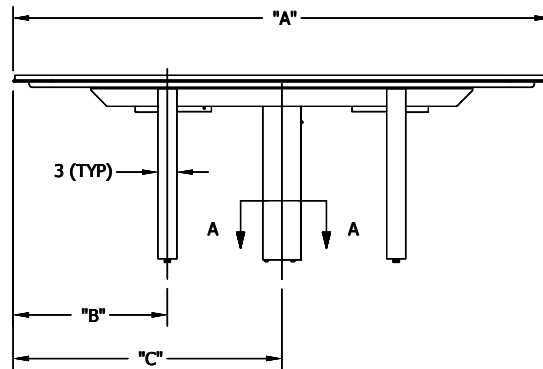
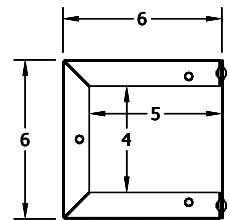

table size	dim "A"	dim "B"	dim "C"
84" x 42"	84 1/2"	24 1/4"	42 1/4"
96" x 48"	96 1/2"	24 1/4"	48 1/4"
108" x 48"	108 1/2"	30 1/4"	54 1/4"
120" x 48"	120 1/2"	36 1/4"	60 1/4"



SECTION A-A

HIGHLINE

base / wire management column locations - tables with 3 bases

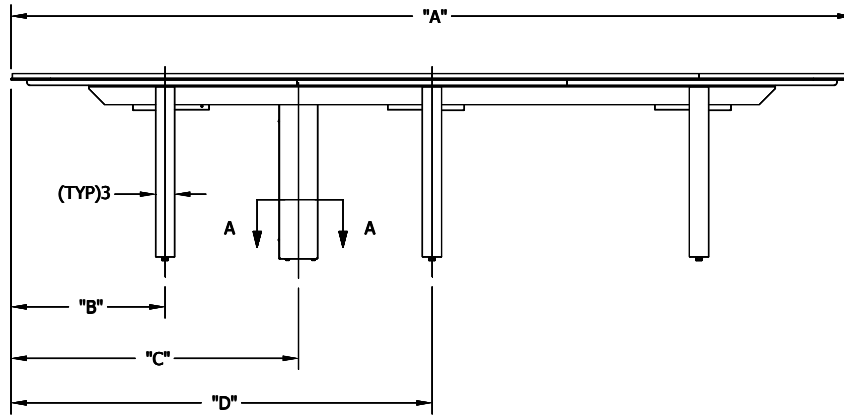
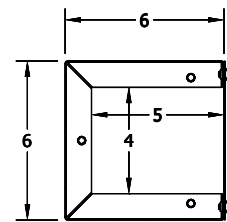

table size	dim "A"	dim "B"	dim "C"	dim "d"
132" x 54"	132 1/2"	24 1/4"	45 1/4"	66 1/4"
144" x 54"	144 1/2"	30 1/4"	51 1/4"	72 1/4"
156" x 60"	156 1/2"	24 1/4"	51 1/4"	78 1/4"
168" x 60"	168 1/2"	30 1/4"	57 1/4"	84 1/4"
180" x 60"	180 1/2"	36 1/4"	63 1/4"	90 1/4"



SECTION A-A

base / wire management column locations - tables with 4 bases

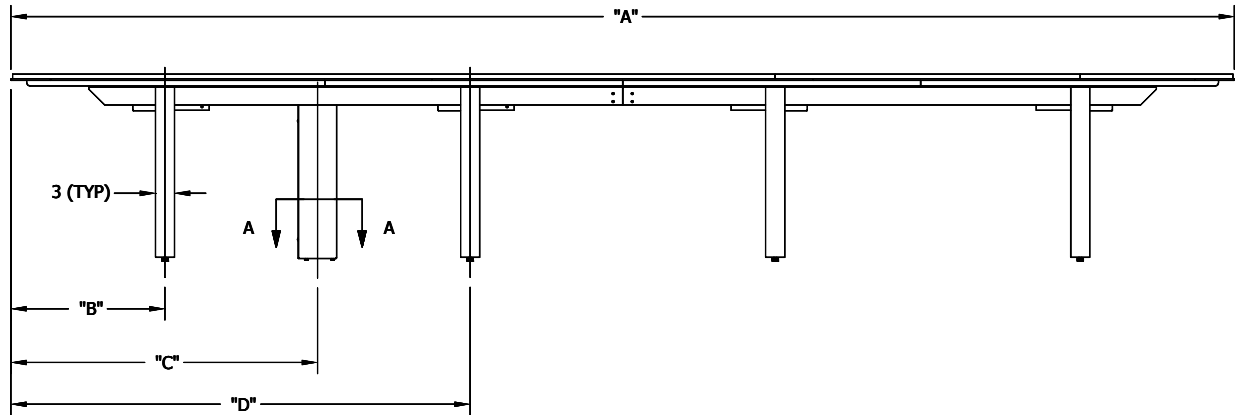
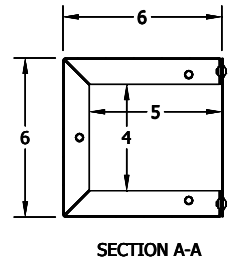
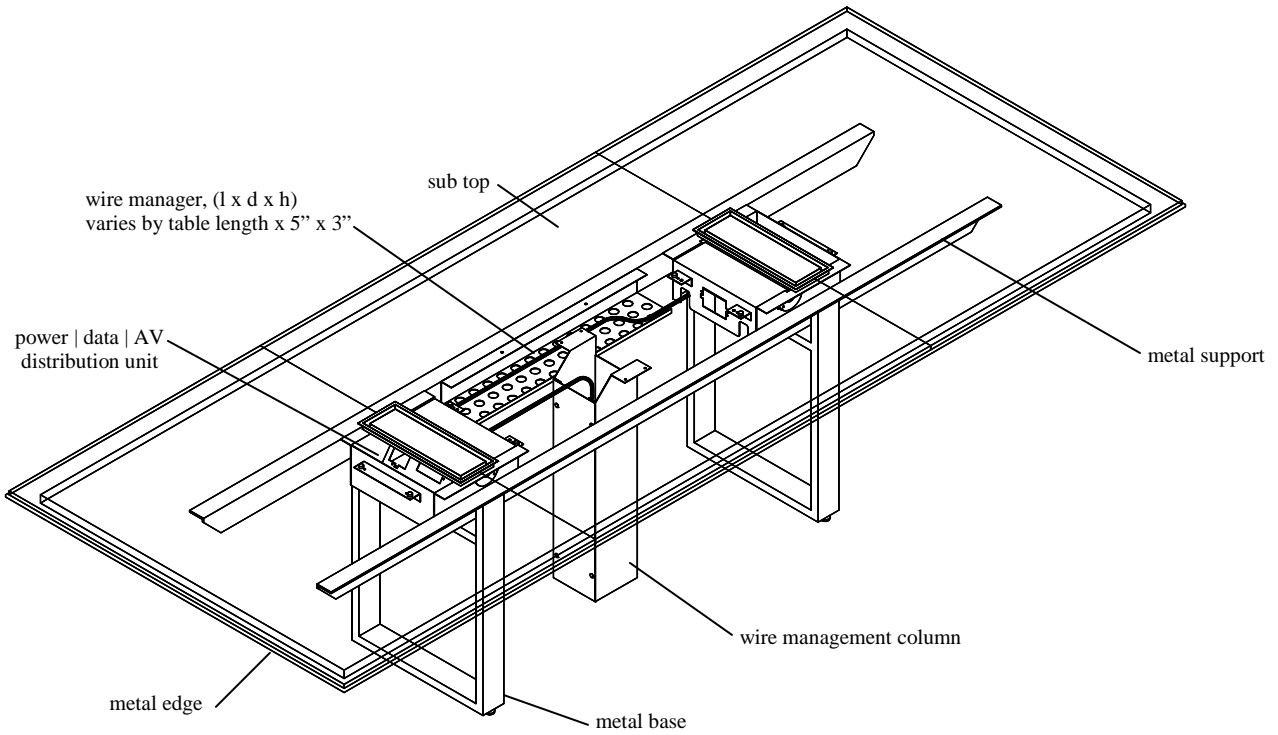

table size	dim "A"	dim "B"	dim "C"	dim "d"
192" x 72"	192 1/2"	24 1/4"	48 1/4"	72 1/4"
204" x 72"	204 1/2"	30 1/4"	54 1/4"	78 1/4"
216" x 72"	216 1/2"	36 1/4"	60 1/4"	84 1/4"
228" x 72"	228 1/2"	30 1/4"	58 1/4"	86 1/4"
240" x 72"	240 1/2"	36 1/4"	64 1/4"	92 1/4"



conference table details



edge options

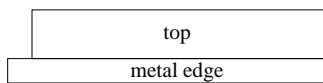

square edge
 1/4" metal edge | 1/2" top
 solid surface | back painted glass

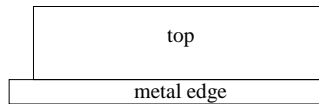

square edge
 1/4" metal edge | 3/4" top
 wood | stone

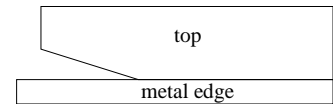

knife edge
 1/4" metal edge | 3/4" top
 wood | stone | solid surface

hatch lid details

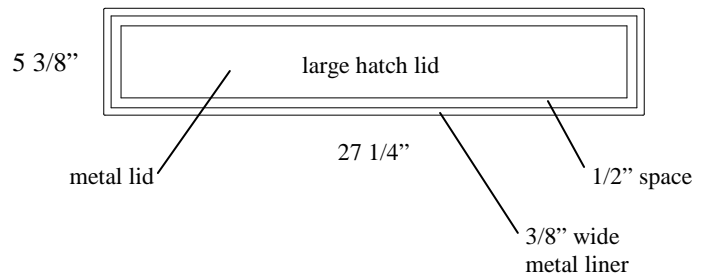
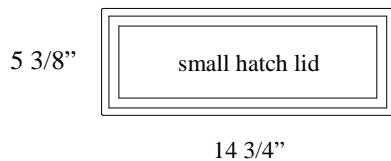

notes

- 1) metal hatch lid finish matches leg finish
- 2) small hatch lid used on tables 42", 48 & 54" wide
- 3) large hatch lid used on tables 60" & 72" wide

power | data | AV distribution unit



small power box - used on tables 42, 48 & 54" wide

- a) (3) standard "old work" one gang cutouts inside power box
- b) (1) standard "old work" one gang cutout on back side of power box for convenience
- c) (2) low voltage CADDY plates included (used to attach decora style face plates & Extron Electronics wallplates)

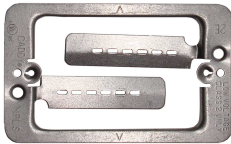

low voltage CADDY plate

used to attach decora style faceplates & Extron Electronics wallplates
(2 included with each power box)

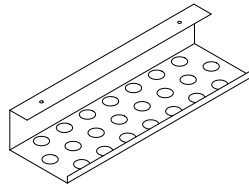

wire manager,
length varies by table length x 5" x 3"
(l x d x h), metal with a black powder
coated finish

large power box - used on tables 60 & 72" wide

- a) (4) standard "old work" one gang cutouts inside power box
- b) (1) standard "old work" one gang cutout on back side of power box for convenience
- c) (2) low voltage CADDY plates included (used to attach decora style face plates & Extron Electronics wallplates)

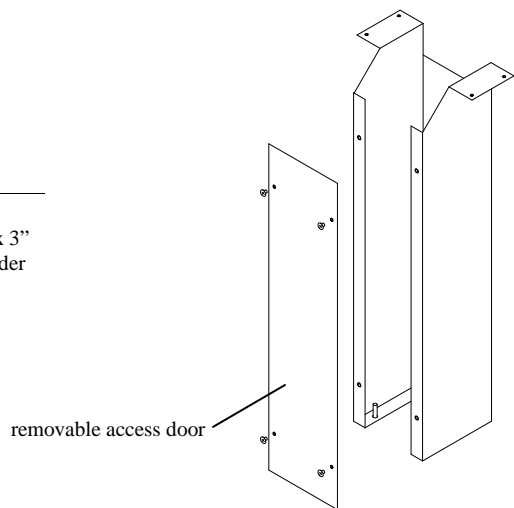

wire management column,
available in 3 powder coated
finishes, see pg. 33

power | data | AV distribution unit, *continued*

all **electrical, data and AV components are supplied by others**

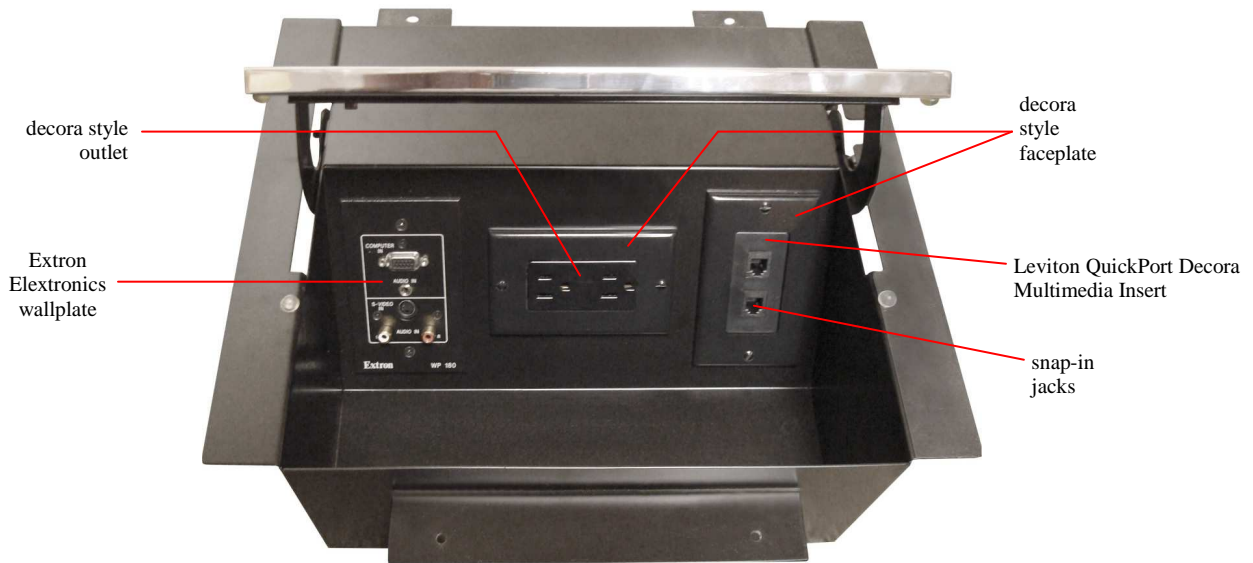

inside of power box

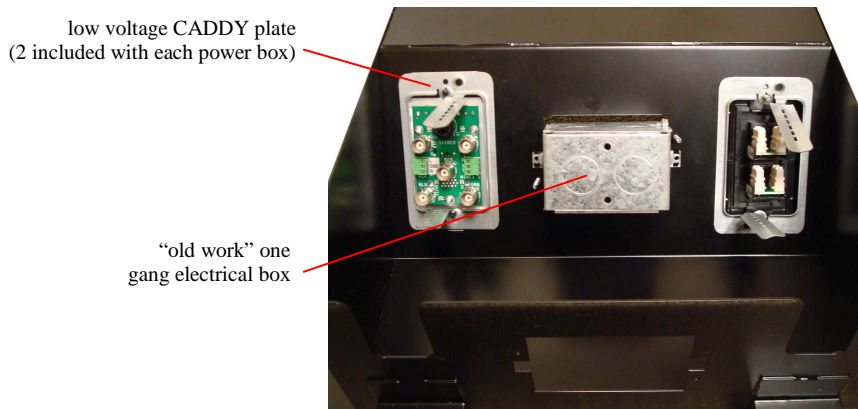

backside of power box

solutions can be sourced from a variety of manufacturers of voice and data equipment. to name a few:

- a) AMP Netconnect products: Flexmode, 110Connect, SL series
- b) Leviton Voice & Data products: Quickport
- c) Panduit Network products: Mini-com
- d) Extron Elelctronics wallplates



"old work" one gang electrical box



Decora style receptacle



decora style faceplate



Extron Elelctronics wallplate



Leviton QuickPort Decora Multimedia Inserts



multimedia jacks that snap-in to QuickPort faceplates.

- a) S-ideo, RCA, F-Connector, 3.5mm Stereo, BNC for example



jacks and terminals that snap-in to Leviton QuickPort Decora Multimedia Inserts

HIGHLINE

meeting table pricing



48" square meeting table

veneer	top thickness	metal finish	no grommet	grommet	add crate (net \$)
standard knife/square edge	3/4"	chrome / satin nickel	\$4,954	\$5,055	n/a
premium knife/square edge	3/4"	chrome / satin nickel	\$5,367	\$5,468	n/a
solid surface	top thickness	metal finish	no grommet	grommet	add crate (net \$)
square edge	1/2"	chrome / satin nickel	\$4,910	\$5,011	\$135
knife edge	3/4"	chrome / satin nickel	\$6,706	\$6,806	\$135
back painted glass	top thickness	metal finish	no grommet	grommet	add crate (net \$)
square edge	1/2"	chrome / satin nickel	\$5,434	\$5,561	\$135
square edge etched	1/2"	chrome / satin nickel	\$6,690	\$6,833	\$135
stone	top thickness	metal finish	no grommet	grommet	add crate (net \$)
standard square edge	3/4"	chrome / satin nickel	\$10,019	\$10,410	\$135
standard knife edge	3/4"	chrome / satin nickel	\$10,214	\$10,605	\$135
premium square edge	3/4"	chrome / satin nickel	\$12,888	\$13,224	\$135
premium knife edge	3/4"	chrome / satin nickel	\$13,223	\$13,559	\$135

*add 10% for oil rubbed bronze metal option

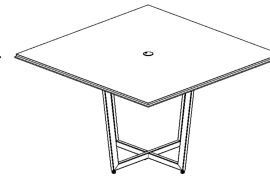
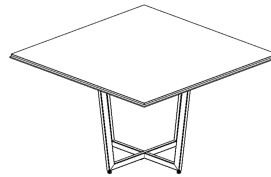



60" square meeting table

veneer	top thickness	metal finish	no grommet	grommet	add crate (net \$)
standard knife/square edge	3/4"	chrome / satin nickel	\$6,502	\$6,614	n/a
premium knife/square edge	3/4"	chrome / satin nickel	\$7,219	\$7,331	n/a
solid surface	top thickness	metal finish	no grommet	grommet	add crate (net \$)
square edge	1/2"	chrome / satin nickel	\$5,599	\$5,700	\$185
knife edge	3/4"	chrome / satin nickel	\$7,850	\$7,951	\$185
back painted glass	top thickness	metal finish	no grommet	grommet	add crate (net \$)
square edge	1/2"	chrome / satin nickel	\$7,733	\$7,875	\$185
square edge etched	1/2"	chrome / satin nickel	\$9,915	\$10,073	\$185
stone	top thickness	metal finish	no grommet	grommet	add crate (net \$)
standard square edge	3/4"	chrome / satin nickel	\$14,916	\$15,337	\$185
standard knife edge	3/4"	chrome / satin nickel	\$15,243	\$15,664	\$185
premium square edge	3/4"	chrome / satin nickel	\$17,691	\$18,027	\$185
premium knife edge	3/4"	chrome / satin nickel	\$18,084	\$18,420	\$185



*add 10% for oil rubbed bronze metal option

- notes
- 1) materials / finishes, see pg. 33
 - 2) edge profiles / details, see pg. 16
 - 3) grommet finish matches metal base finish
 - 4) table height +/-29 1/4"
 - 5) base information, see pg. 5
 - 6) top sections are for reference when using stone, top sections are subject to change based on availability of stone material

meeting table pricing, *continued*

							
48" diameter meeting table							
veneer	top thickness	metal finish	no grommet	grommet	add crate (net \$)		
standard knife/square edge	3/4"	chrome / satin nickel	\$5,402	\$5,493	n/a		
premium knife/square edge	3/4"	chrome / satin nickel	\$6,266	\$6,367	n/a		
solid surface	top thickness	metal finish	no grommet	grommet	add crate (net \$)		
square edge	1/2"	chrome / satin nickel	\$6,047	\$6,147	\$135		
knife edge	3/4"	chrome / satin nickel	\$8,078	\$8,178	\$135		
back painted glass	top thickness	metal finish	no grommet	grommet	add crate (net \$)		
square edge	1/2"	chrome / satin nickel	\$6,282	\$6,397	\$135		
square edge etched	1/2"	chrome / satin nickel	\$7,595	\$7,725	\$135		
stone	top thickness	metal finish	no grommet	grommet	add crate (net \$)		
standard square edge	3/4"	chrome / satin nickel	\$10,581	\$10,939	\$135		
standard knife edge	3/4"	chrome / satin nickel	\$10,848	\$11,206	\$135		
premium square edge	3/4"	chrome / satin nickel	\$14,720	\$15,057	\$135		
premium knife edge	3/4"	chrome / satin nickel	\$14,971	\$15,308	\$135		

*add 10% for oil rubbed bronze metal option

							
60" diameter meeting table							
veneer	top thickness	metal finish	no grommet	grommet	add crate (net \$)		
standard knife/square edge	3/4"	chrome / satin nickel	\$6,220	\$6,311	n/a		
premium knife/square edge	3/4"	chrome / satin nickel	\$7,348	\$7,449	n/a		
solid surface	top thickness	metal finish	no grommet	grommet	add crate (net \$)		
square edge	1/2"	chrome / satin nickel	\$6,805	\$6,906	\$185		
knife edge	3/4"	chrome / satin nickel	\$9,569	\$9,670	\$185		
back painted glass	top thickness	metal finish	no grommet	grommet	add crate (net \$)		
square edge	1/2"	chrome / satin nickel	\$7,503	\$7,613	\$185		
square edge etched	1/2"	chrome / satin nickel	\$9,447	\$9,570	\$185		
stone	top thickness	metal finish	no grommet	grommet	add crate (net \$)		
standard square edge	3/4"	chrome / satin nickel	\$14,948	\$15,321	\$185		
standard knife edge	3/4"	chrome / satin nickel	\$15,384	\$15,758	\$185		
premium square edge	3/4"	chrome / satin nickel	\$19,473	\$19,809	\$185		
premium knife edge	3/4"	chrome / satin nickel	\$19,996	\$20,332	\$185		

*add 10% for oil rubbed bronze metal option

notes

- 1) materials / finishes, see pg. 33
- 2) edge profiles / details, see pg. 16
- 3) grommet finish matches metal base finish
- 4) table height +/-29 1/4"
- 5) base information, see pg. 5
- 6) top sections are for reference when using stone, top sections are subject to change based on availability of stone material

1 high credenza component pricing

available lengths
 -87" (18" end cabinets)
 -99" (24" end cabinets)

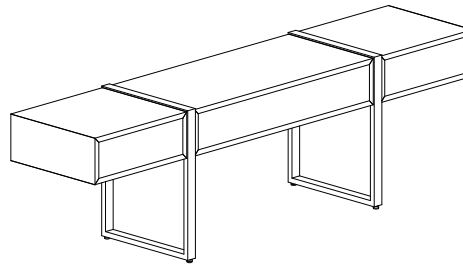

legs

options	leg
chrome satin chrome	\$775

*price per leg

1 high open cabinet

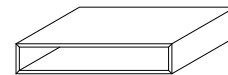
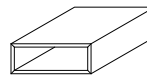
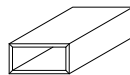

options	18" end	24" end	47" center
standard wood	\$1,748	\$1,942	\$2,489
premium wood	\$1,826	\$2,060	\$2,654
paint	\$1,642	\$1,865	\$2,378

1 high drawer cabinet

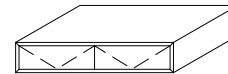
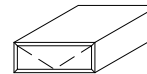
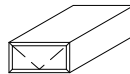

options	18" end	24" end	47" center
standard wood	\$1,760	\$1,957	\$2,526
premium wood	\$1,837	\$2,083	\$2,684
paint	\$1,685	\$1,903	\$2,466

1 high top options

options	18" top	24" top	47" top	87" top	99" top	add crate (net \$)
solid surface	\$249	\$336	\$663	n/a	n/a	\$150
back painted glass	\$232	\$237	\$495	n/a	n/a	\$150
back painted glass top etched	\$372	\$379	\$791	n/a	n/a	\$150
standard stone top	\$916	\$1,260	\$2,562	n/a	n/a	\$150
premium stone top	\$1,658	\$2,279	\$4,636	n/a	n/a	\$150
1 piece glass water clear glass	n/a	n/a	n/a	\$896	\$1,018	\$150

- notes
- 1) materials / finishes, see pg. 33
 - 2) credenza details / information, see pg. 30-31
 - 3) pulls match leg finish
 - 4) all drawers have a 2" tab pull that is located in the center of the top edge of each drawer front
 - 5) all drawers are equipped with partial extension, self closing under mount drawer slides
 - 6) all doors are equipped with free swing hinges and touch latch's
 - 7) pricing examples, see pg. 23
 - 8) add 10% to credenza list price for oil rubbed bronze metal option
 - 9) leg information, see pg. 5

1 high credenza pricing examples

1 high credenza example 1.1

component	description	finish	list price	
left cabinet	open, 24" end	paint	\$1,865	
center cabinet	open, 47" center	paint	\$2,378	
right cabinet	open, 24" end	paint	\$1,865	
leg	(2) metal legs	chrome	\$1,551	\$7,659 total list (credenza)
top option 1	(3) section top	back painted glass	\$969	\$8,628 total list (credenza + top)
top option 2	(3) section top	solid surface	\$1,335	\$8,994 total list (credenza + top)
top option 3	(3) section top	standard stone	\$5,081	\$12,740 total list (credenza + top)
top option 4	(3) section top	premium stone	\$9,195	\$16,853 total list (credenza + top)
top option 5	(1) piece top	GG09 water clear glass	\$1,018	\$8,677 total list (credenza + top)

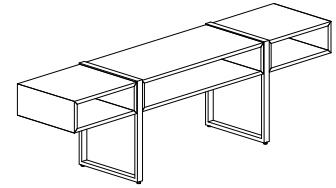

*add 10% for oil rubbed bronze metal option

1 high credenza example 1.2

component	description	finish	list price	
left cabinet	drawer, 24" end	paint	\$1,903	
center cabinet	drawer, 47" center	paint	\$2,339	
right cabinet	drawer, 24" end	paint	\$1,903	
leg	(2) metal legs	chrome	\$1,551	\$7,697 total list (credenza)
top option 1	(3) section top	back painted glass	\$969	\$8,666 total list (credenza + top)
top option 2	(3) section top	solid surface	\$1,335	\$9,032 total list (credenza + top)
top option 3	(3) section top	standard stone	\$5,081	\$12,778 total list (credenza + top)
top option 4	(3) section top	premium stone	\$9,195	\$16,891 total list (credenza + top)
top option 5	(1) piece top	GG09 water clear glass	\$1,018	\$8,715 total list (credenza + top)

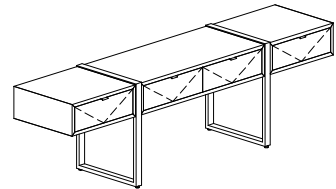

*add 10% for oil rubbed bronze metal option

notes

- 1) materials / finishes, see pg. 33
- 2) credenza details / information, see pg. 30-31
- 3) pulls match leg finish
- 4) all drawers have a 2" tab pull that is located in the center of the top edge of each drawer front
- 5) all drawers are equipped with partial extension, self closing under mount drawer slides
- 6) all doors are equipped with free swing hinges and touch latch's
- 7) leg information, see pg. 5
- 8) all credenza case top options are secured to the case with silicone excluding the 1 piece water clear glass top option
- 9) 1 piece water clear glass top option sets on top of non-skidding bumpers located on top of legs

2 high credenza component pricing

available lengths
 -87" (18" end cabinets)
 -99" (24" end cabinets)

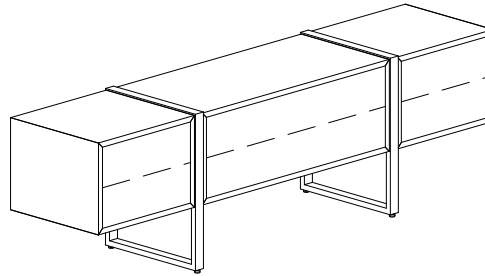

legs

options	leg
chrome satin chrome	\$775

*price per leg

2 high open over drawer cabinet

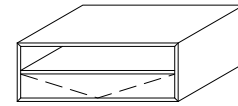
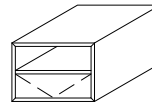
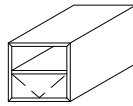

options	18" end	24" end	47" center
standard wood	\$2,221	\$2,440	\$3,128
premium wood	\$2,301	\$2,571	\$3,293
paint	\$2,071	\$2,298	\$2,963

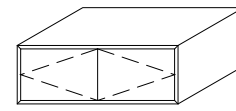
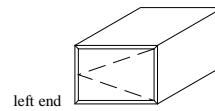
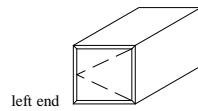
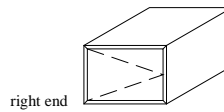
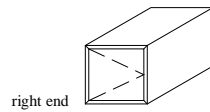

2 high door w/adjustable shelf cabinets

options	18" end	24" end	47" center
standard wood	\$2,262	\$2,494	\$3,310
premium wood	\$2,339	\$2,610	\$3,493
paint	\$2,071	\$2,308	\$3,028

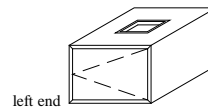
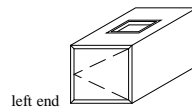
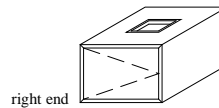
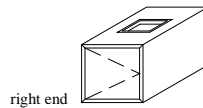

2 high door w/trash cabinets

options	18" end	24" end
standard wood	\$2,536	\$2,755
premium wood	\$2,612	\$2,868
paint	\$2,366	\$2,604

2 high credenza component pricing, *continued*

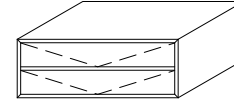
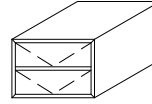
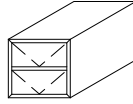

2 high drawer cabinets

options	18" end	24" end	47" center
standard wood	\$2,052	\$2,283	\$3,308
premium wood	\$2,133	\$2,407	\$3,474
paint	\$1,954	\$2,208	\$3,197

2 high top options

options	18" top	24" top	47" top	87" top	99" top	add crate (net \$)
solid surface	\$249	\$336	\$663	n/a	n/a	\$150
back painted glass	\$232	\$237	\$495	n/a	n/a	\$150
back painted glass top etched	\$372	\$379	\$791	n/a	n/a	\$150
standard stone top	\$916	\$1,260	\$2,562	n/a	n/a	\$150
premium stone top	\$1,658	\$2,279	\$4,636	n/a	n/a	\$150
solid surface trash	\$249	\$336	n/a	n/a	n/a	\$150
back painted glass trash	\$298	\$303	n/a	n/a	n/a	\$150
back painted glass top etched trash	\$476	\$484	n/a	n/a	n/a	\$150
standard stone top trash	\$1,287	\$1,630	n/a	n/a	n/a	\$150
premium stone top trash	\$2,028	\$2,650	n/a	n/a	n/a	\$150
1 piece glass water clear glass	n/a	n/a	n/a	\$896	\$1,018	\$150

notes

- 1) materials / finishes, see pg. 33
- 2) credenza details / information, see pg. 30-31
- 3) pulls and trash liners match leg finish
- 4) all drawers have a 2" tab pull that is located in the center of the top edge of each drawer front
- 5) all drawers are equipped with partial extension, self closing under mount drawer slides
- 6) all doors are equipped with free swing hinges and touch latch's
- 7) pricing examples, see pg. 26
- 8) add 10% to credenza list price for oil rubbed bronze metal option
- 9) leg information, see pg. 5

2 high credenza pricing examples

2 high credenza example 2.1

component	description	finish	list price	
left cabinet	door w/ adjustable shelf, 24" end	standard veneer	\$2,494	
center cabinet	open over drawer, 47" center	standard veneer	\$3,128	
right cabinet	door w/ adjustable shelf, 24" end	standard veneer	\$2,494	
leg	(2) metal legs	chrome	\$1,551	\$9,667 total list (credenza)
top option 1	(3) section top	back painted glass	\$969	\$10,636 total list (credenza + top)
top option 2	(3) section top	solid surface	\$1,335	\$11,002 total list (credenza + top)
top option 3	(3) section top	standard stone	\$5,081	\$14,749 total list (credenza + top)
top option 4	(3) section top	premium stone	\$9,195	\$18,862 total list (credenza + top)
top option 5	(1) piece top	GG09 water clear glass	\$1,018	\$10,686 total list (credenza + top)

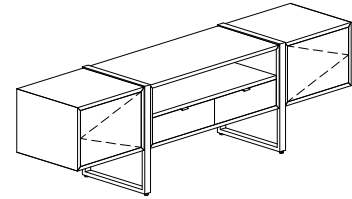

*add 10% for oil rubbed bronze metal option

2 high credenza example 2.2

component	description	finish	list price	
left cabinet	door w/ adjustable shelf, 24" end	standard veneer	\$2,494	
center cabinet	door w/ adjustable shelf, 47" center	standard veneer	\$3,310	
right cabinet	door w/ adjustable shelf, 24" end	standard veneer	\$2,494	
leg	(2) metal legs	chrome	\$1,551	\$9,849 total list (credenza)
top option 1	(3) section top	back painted glass	\$969	\$10,818 total list (credenza + top)
top option 2	(3) section top	solid surface	\$1,335	\$11,184 total list (credenza + top)
top option 3	(3) section top	standard stone	\$5,081	\$14,930 total list (credenza + top)
top option 4	(3) section top	premium stone	\$9,195	\$19,044 total list (credenza + top)
top option 5	(1) piece top	GG09 water clear glass	\$1,018	\$10,867 total list (credenza + top)

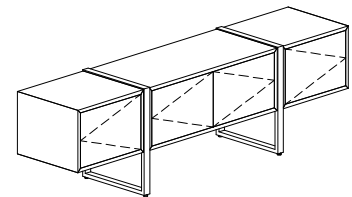

- notes
- materials / finishes, see pg. 33
 - credenza details / information, see pg. 30-31
 - pulls and trash liners match leg finish
 - all drawers have a 2" tab pull that is located in the center of the top edge of each drawer front
 - all drawers are equipped with partial extension, self closing under mount drawer slides
 - all doors are equipped with free swing hinges and touch latch's
 - leg information, see pg. 5
 - all credenza case top options are secured to the case with silicone excluding the 1 piece water clear glass top option
 - 1 piece water clear glass top option sets on top of non-skidding bumpers located on top of legs

3 high credenza component pricing

available lengths
 -87" (18" end cabinets)
 -99" (24" end cabinets)

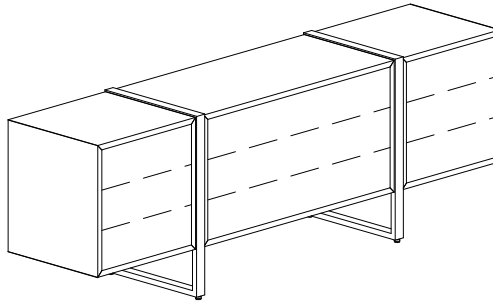

legs	
options	leg
chrome satin chrome	\$775

**price per leg*

3 high open over drawer cabinet

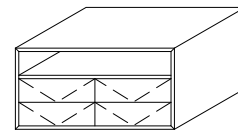
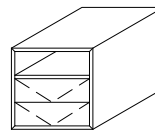
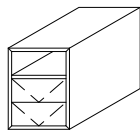

options	18" end	24" end	47" center
standard wood	\$2,778	\$3,035	\$3,994
premium wood	\$2,860	\$3,156	\$4,154
paint	\$2,569	\$2,835	\$3,739

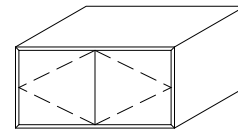
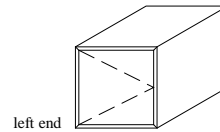
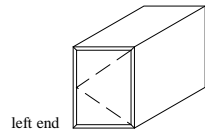
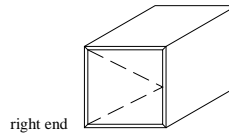
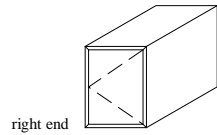

3 high door w/adjustable shelf cabinets

options	18" end	24" end	47" center
standard wood	\$2,675	\$2,927	\$3,818
premium wood	\$2,748	\$3,044	\$3,977
paint	\$2,443	\$2,683	\$3,443

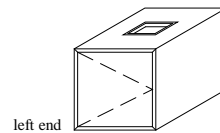
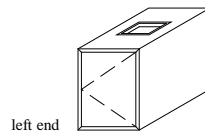
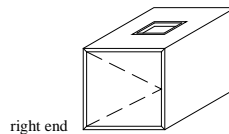
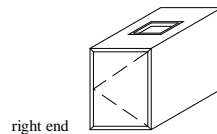

3 high door w/trash cabinets

options	18" end	24" end
standard wood	\$2,939	\$3,167
premium wood	\$3,013	\$3,291
paint	\$2,730	\$2,970

HIGHLINE

3 high credenza component pricing, *continued*

* please coordinate AV requirement needs with the interior clearance dimensions provided below to ensure proper fit with AV cabinets. The exact dimensions of interior clearance space are as follows:

-18" wide end (WxDxH): 14.25" x 22.18" x 21.15"

-24" wide end (WxDxH): 20.25" x 22.18" x 21.15"

-47" wide center (WxDxH): 41.25" x 22.18" x 21.15"

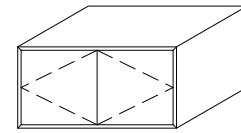
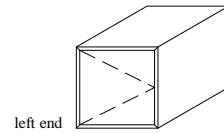
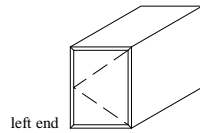
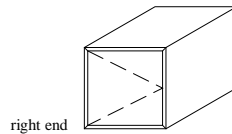
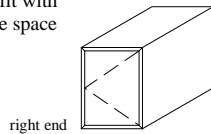

3 high door w/av cutout cabinets

options	18" end	24" end	47" center
standard wood	\$2,634	\$2,865	\$3,624
premium wood	\$2,717	\$2,997	\$3,806
paint	\$2,420	\$2,661	\$3,349

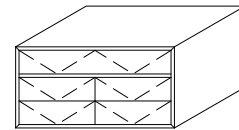
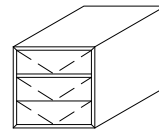
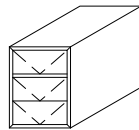

3 high drawer cabinets

options	18" end	24" end	47" center
standard wood	\$2,588	\$2,848	\$4,051
premium wood	\$2,668	\$2,968	\$4,205
paint	\$2,451	\$2,728	\$3,872

3 high top options

options	18" top	24" top	47" top	87" top	99" top	add crate (net \$)
solid surface	\$249	\$336	\$663	n/a	n/a	\$150
back painted glass	\$232	\$261	\$598	n/a	n/a	\$150
back painted glass top etched	\$372	\$417	\$957	n/a	n/a	\$150
standard stone top	\$1,008	\$1,386	\$2,818	n/a	n/a	\$150
premium stone top	\$1,823	\$2,507	\$5,100	n/a	n/a	\$150
solid surface trash	\$249	\$336	n/a	n/a	n/a	\$150
back painted glass trash	\$298	\$326	n/a	n/a	n/a	\$150
back painted glass top etched trash	\$476	\$522	n/a	n/a	n/a	\$150
standard stone top trash	\$1,378	\$1,756	n/a	n/a	n/a	\$150
premium stone top trash	\$2,194	\$2,878	n/a	n/a	n/a	\$150
1 piece glass water clear glass	n/a	n/a	n/a	\$910	\$1,103	\$150

notes

- 1) materials / finishes, see pg. 33
- 2) credenza details / information, see pg. 30-31
- 3) pulls and trash liners match leg finish
- 4) all drawers have a 2" tab pull that is located in the center of the top edge of each drawer front
- 5) all drawers are equipped with partial extension, self closing under mount drawer slides
- 6) all doors are equipped with free swing hinges and touch latch's
- 7) pricing examples, see pg. 29
- 8) add 10% to credenza list price for oil rubbed bronze metal option
- 9) leg information, see pg. 5

3 high credenza pricing examples

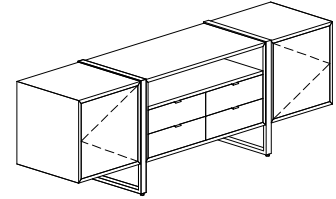

3 high credenza example 3.1

component	description	finish	list price	
left cabinet	door w/ adjustable shelf, 24" end	standard veneer	\$2,927	
center cabinet	open over drawer, 47" center	standard veneer	\$3,994	
right cabinet	door w/ adjustable shelf, 24" end	standard veneer	\$2,927	
leg	(2) metal legs	chrome	\$1,551	\$11,399 total list (credenza)
top option 1	(3) section top	back painted glass	\$1,120	\$12,519 total list (credenza + top)
top option 2	(3) section top	solid surface	\$1,335	\$12,734 total list (credenza + top)
top option 3	(3) section top	standard stone	\$5,589	\$16,988 total list (credenza + top)
top option 4	(3) section top	premium stone	\$10,114	\$21,513 total list (credenza + top)
top option 5	(1) piece top	GG09 water clear glass	\$1,103	\$12,502 total list (credenza + top)

*add 10% for oil rubbed bronze metal option

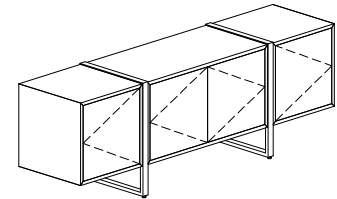

3 high credenza example 3.2

component	description	finish	list price	
left cabinet	door w/ adjustable shelf, 24" end	standard veneer	\$2,927	
center cabinet	door w/ adjustable shelf, 47" center	standard veneer	\$3,818	
right cabinet	door w/ adjustable shelf, 24" end	standard veneer	\$2,927	
leg	(2) metal legs	chrome	\$1,551	\$11,223 total list (credenza)
top option 1	(3) section top	back painted glass	\$1,120	\$12,343 total list (credenza + top)
top option 2	(3) section top	solid surface	\$1,335	\$12,558 total list (credenza + top)
top option 3	(3) section top	standard stone	\$5,589	\$16,812 total list (credenza + top)
top option 4	(3) section top	premium stone	\$10,114	\$21,337 total list (credenza + top)
top option 5	(1) piece top	GG09 water clear glass	\$1,103	\$12,326 total list (credenza + top)

*add 10% for oil rubbed bronze metal option

notes

- 1) materials / finishes, see pg. 33
- 2) credenza details / information, see pg. 30-31
- 3) pulls and trash liners match leg finish
- 4) all drawers have a 2" tab pull that is located in the center of the top edge of each drawer front
- 5) all drawers are equipped with partial extension, self closing under mount drawer slides
- 6) all doors are equipped with free swing hinges and touch latch's
- 7) leg information, see pg. 5
- 8) all credenza case top options are secured to the case with silicone excluding the 1 piece water clear glass top option
- 9) 1 piece water clear glass top option sets on top of non-skidding bumpers located on top of legs

credenza details

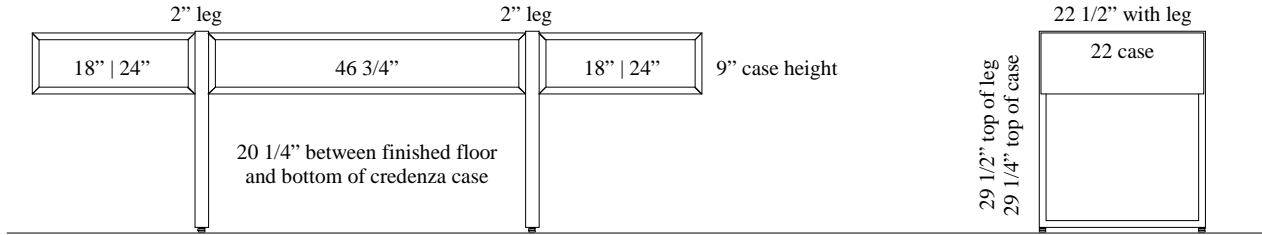

1 high credenza

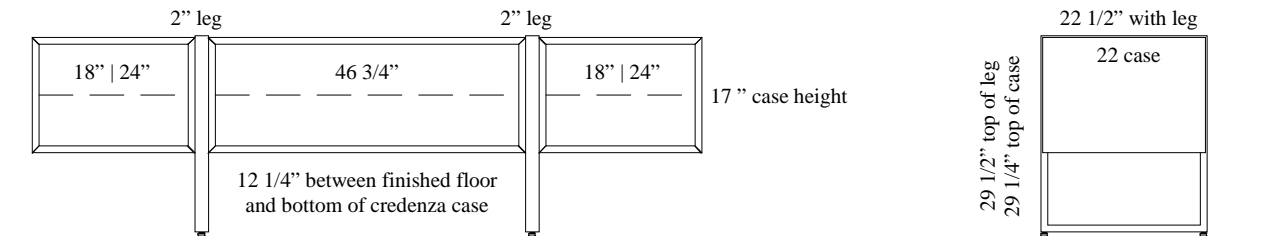

2 high credenza

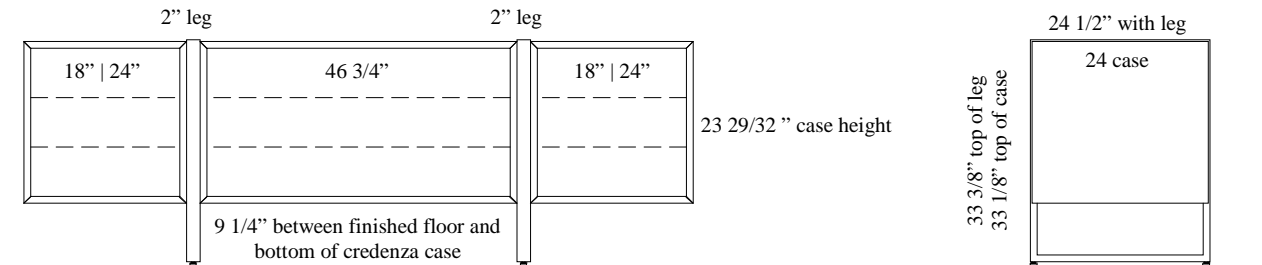

3 high credenza

credenza details, *continued*

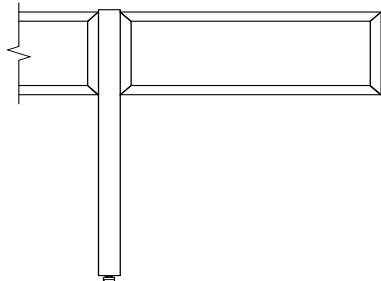

no top

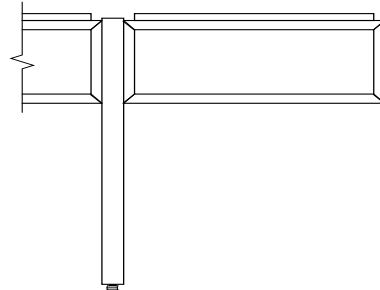

stone top, 2cm thick

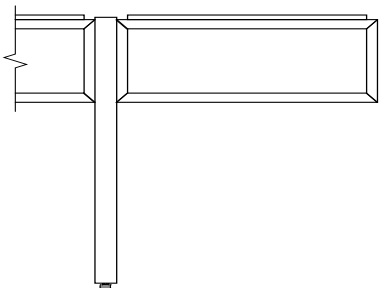

back painted glass / solid surface top, 1/4" thick

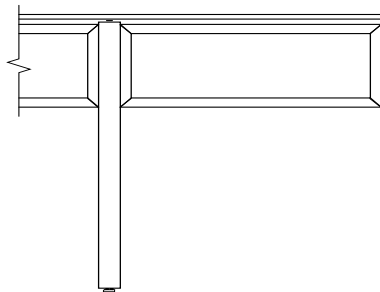

1 piece water clear glass top, 1/2" thick

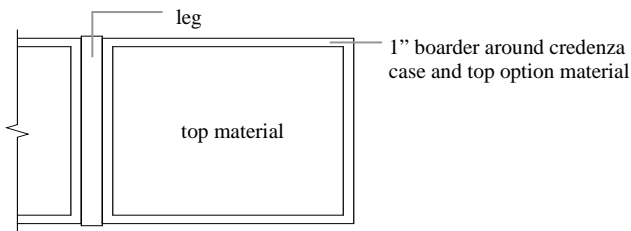

top view of credenza w/ back painted glass / solid surface / stone top option

metal liner on trash option
matches leg finish

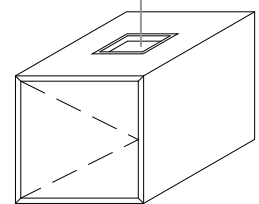

trash option

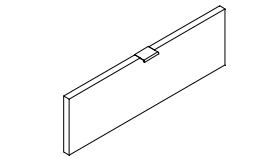

drawer with 2" tab pull

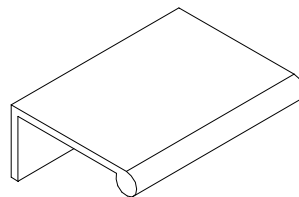

2" tab pull

notes

- 1) materials / finishes, see pg. 33
- 2) pulls and trash liners match leg finish
- 3) all drawers have a 2" tab pull that is located in the center of the top edge of each drawer front
- 4) all drawers are equipped with partial extension, self closing under mount drawer slides
- 5) all doors are equipped with free swing hinges and touch latch's
- 6) leg information, see pg. 5
- 7) all credenza case top options are secured to the case with silicone excluding the 1 piece water clear glass top option
- 8) 1 piece water clear glass top option sets on top of non-skidding bumpers located on top of legs
- 9) trash option also available with all top options excluding the 1 piece water clear glass top option

accessory box pricing

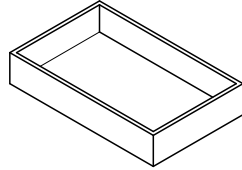

accessory box

options	10" x 16"
paint	280
leather	299

**prices shown are per box*

notes

- 1) all accessory boxes are lined with black felt on the bottom and inside surfaces

finishes / materials

standard veneers

W01 quartered figured anigre | natural
 W02 quartered european oak | natural
 W05 plain sliced walnut | natural
 W06 plain sliced walnut | smoked
 W07 plain sliced walnut | dark

premium veneers

W03 quartered european oak | cerused | medium
 W04 quartered european oak | cerused | dark

solid surface

N01 white

back painted glass

GG01 white
 GE01 white | acid etched
 GG02 grey
 GE02 grey | acid etched
 GG03 black
 GE03 black | acid etched
 GG04 coco
 GE04 coco | acid etched
 GG05 lime green
 GE05 lime green | acid etched
 GG06 light yellow
 GE06 light yellow | acid etched
 GG07 light blue
 GE07 light blue
 GG08 hot pink
 GE08 hot pink | acid etched

standard stone

S01 nero marquina
 S03 white carrara

premium Stone

S02 calcutta gold

conference table power post powder coats

P06 warm grey
 P07 soft white
 P08 black

metal finishes

M01 polished chrome
 M02 satin nickel
 M03 oil rubbed bronze

credenza case paint

P05 white 50% sheen

accessory box paints

P01 smoke white 90% sheen
 P02 soft grey 90% sheen
 P03 deep orange 90% sheen
 P04 white 90% sheen

accessory box leathers

L01 georgian
 L02 parchment
 L03 horsehair
 L04 aquamarine
 L05 fields
 L06 camel

clear glass (only for 87" & 99" credenza leng

GG09 water clear glass | low iron

DATESWEISER

**DATESWEISER FURNITURE CORP
WWW.DATESWEISER.COM**

CORPORATE OFFICE/FACTORY
1700 BROADWAY STREET
BUFFALO NEW YORK 14212
P 716.891.1700 F 716.891.0399

NATIONAL SALES OFFICE
45 W21ST STREET, 2ND FLOOR
NEW YORK, NEW YORK 10010
P 212.727.8855 F 212.727.8555